

SPECIFICATIONS

CONTACT RATING: Dependent upon contact material See Page 130.

MECHANICAL LIFE: 50,000 make-and-break cycles.

CONTACT RESISTANCE: 20 mΩ max. initial @ 2-4VDC
100mA for both silver and gold plated contacts.

INSULATION RESISTANCE: 1,000 MΩ min.

DIELECTRIC STRENGTH: 1,000 Vrms min.@sea level.

OPERATING TEMPERATURE: -30°C to 85°C.

MATERIALS

CASE: Diallyl phthalate(DAP) (UL94V-0).

PLUNGER: Thermoplastic Polyester-black.

BUSHING: Brass or zinc,nickel plated.

HOUSING: Stainless Steel.

SWITCH SUPPORT: Brass.tin plated.

CONTACT/TERMINAL: Brass, with silver or gold plated.

(See Page 130)



HOW TO ORDER

MODEL NO. ACTUATOR BUSHING FRAME COLOR CAP COLOR TERMINATIONS CONTACT MATERIAL SEAL RoHS SOLDERING CAPS CAP COLOR

See below
(only for bushing AP1)

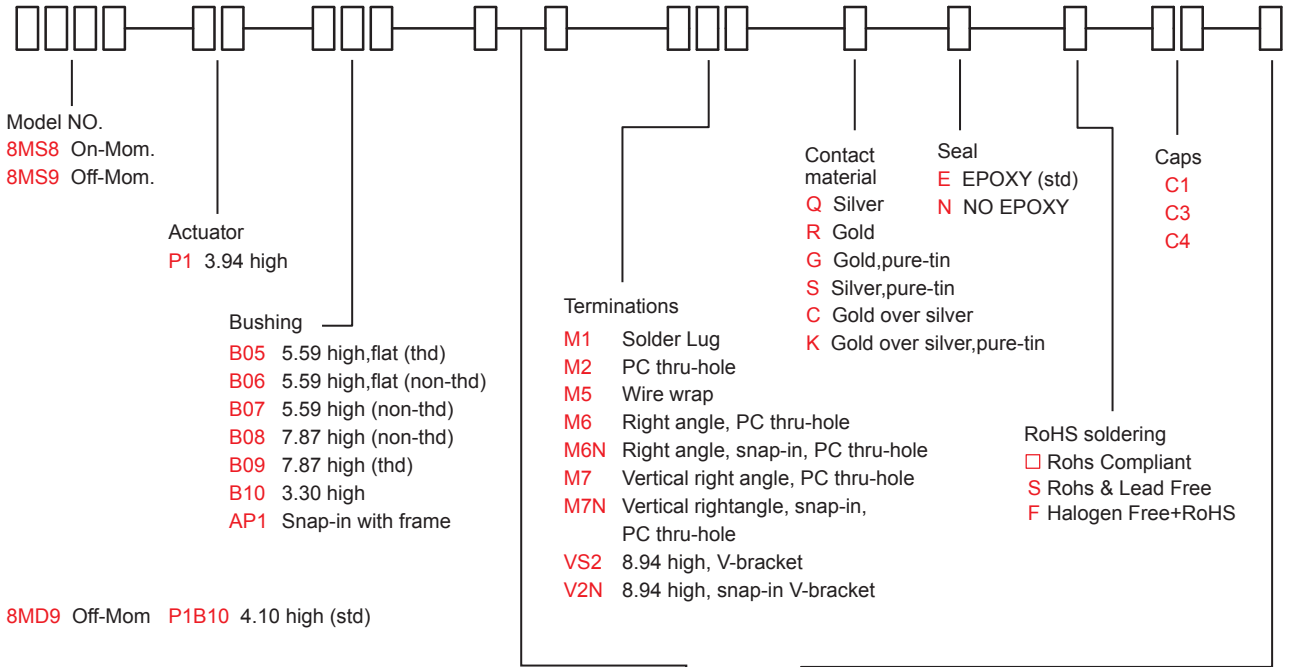

Model NO. Actuator Bushing
8MSL On-On P1 4.29 high B05 5.24 high,flat (thd)
B06 5.24 high,flat (non-thd)

Frame/Cap color

ITEM NO	COLOR
1	White
2	Black (Std)
3	Red
4	Orange
5	Yellow
6	Green
7	Blue
8	Brown
9	Gray



SWITCH FUNCTION

NO. POLES	UL/CSA MODEL NO.	MODEL NO.	SWITCH FUNCTION		CONNECTED TERMINALS / SCHEMATIC	
			POS.1	POS.2	POS.1	POS.2
SP	Q2818	8MS8	ON	MOM	2-1 	2-3
	Q2819	8MS9	OFF	MOM	OPEN	1-3
DP	Q2829	8MD9	OFF	MOM	OPEN	1-3,4-6

MOM=MOMENTARY

POLE OPTIONS

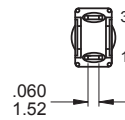
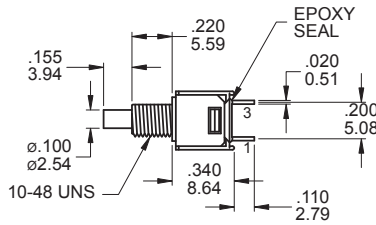
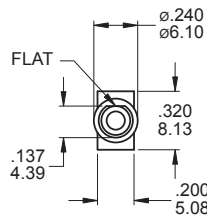

SPST

Part No. Shown : 8MS9P1B05M1QE

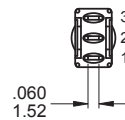
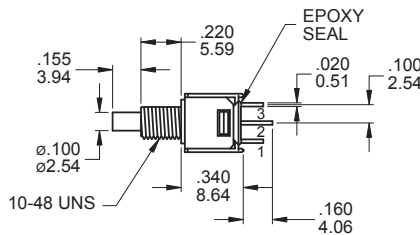
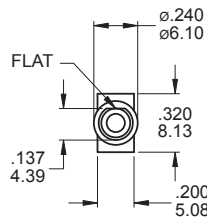

SPDT

Part No. Shown : 8MS8P1B05M1QE

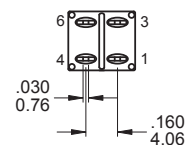
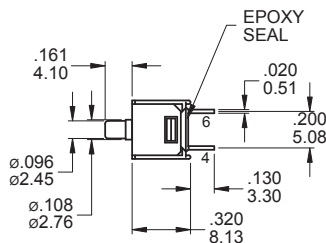
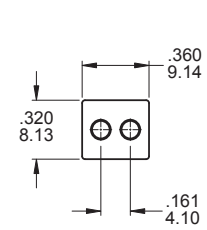

DPST

Part No. Shown : 8MD9P1B10M2RE



BUSHING OPTIONS

B05 THD

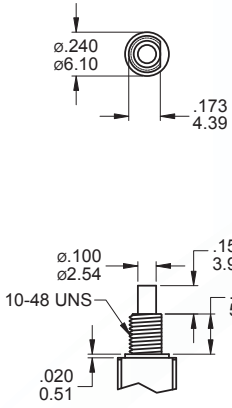

B06 NON-THD

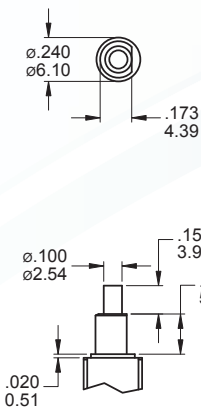

B07 NON-THD

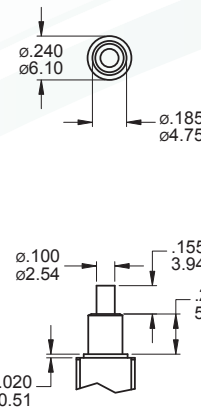

**B08 NON-THD
B09 THD**

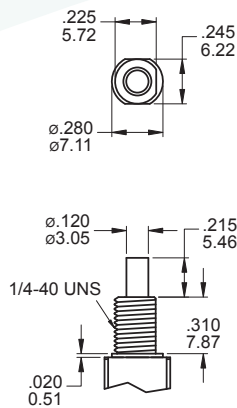

B10

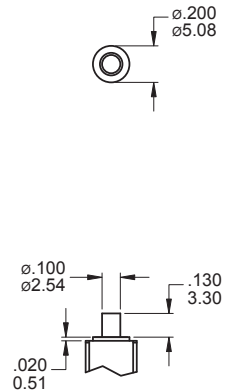

TERMINATION OPTIONS

M1 Solder lug

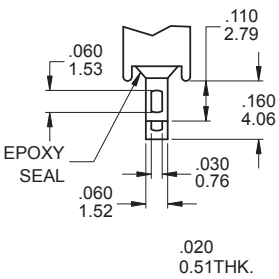

M2 PC Thru-hole

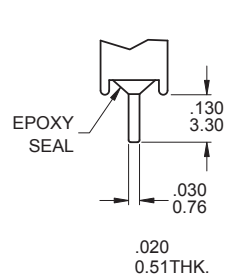

M5 Wire Wrap

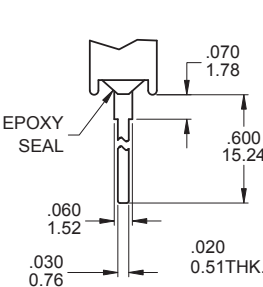

OTHER TERMINATION OPTIONS

- M6** RIGHT ANGLE P.C. MOUNT
- M6N** RIGHT ANGLE P.C. MOUNT WITH SNP-IN BRACKET
- M7** RIGHT ANGLE P.C. MOUNT
- VS2** VERTICAL BRACKET P.C. MOUNT

M6

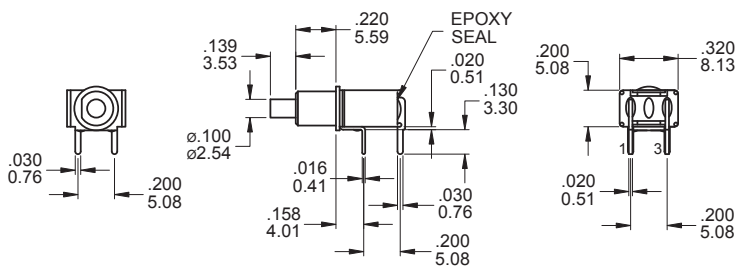

P.C. MOUNTING

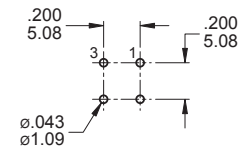

SPST

Part No. Shown : 8MS9P1B06M6RE

M6

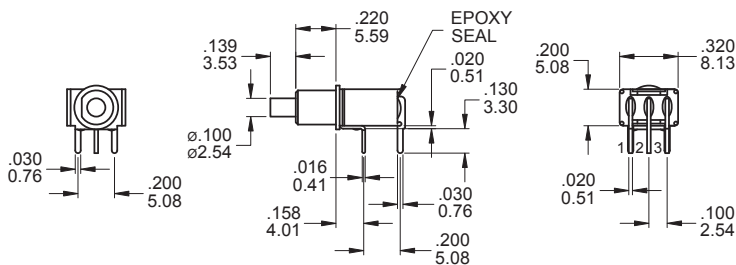

P.C. MOUNTING

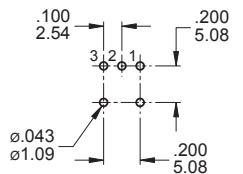

SPDT

Part No. Shown : 8MS8P1B06M6QE

M6

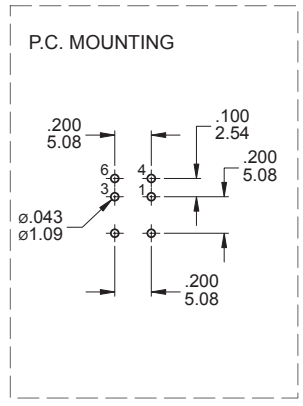
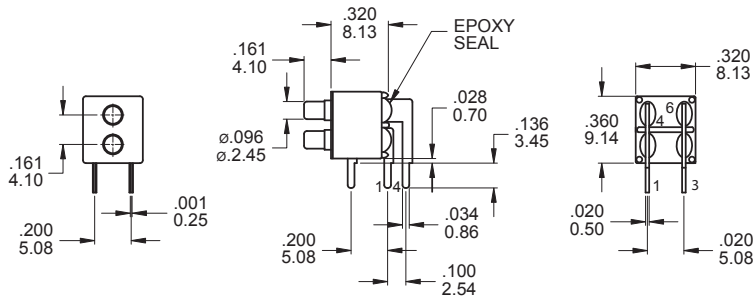

DPST

Part No. Shown : 8MD9P1B10M6RE

M7

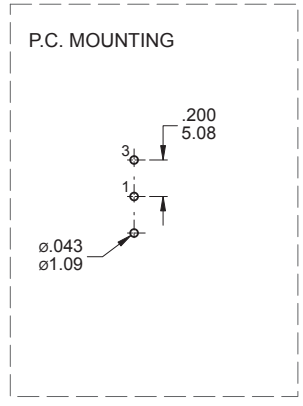
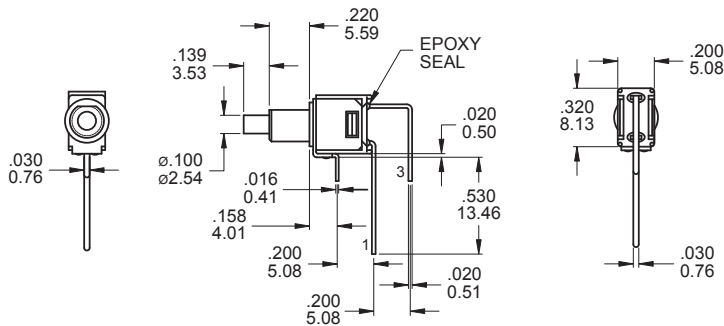

SPST

Part No. Shown : 8MS9P1B06M7QE

M7

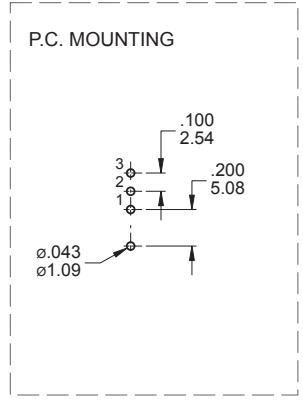
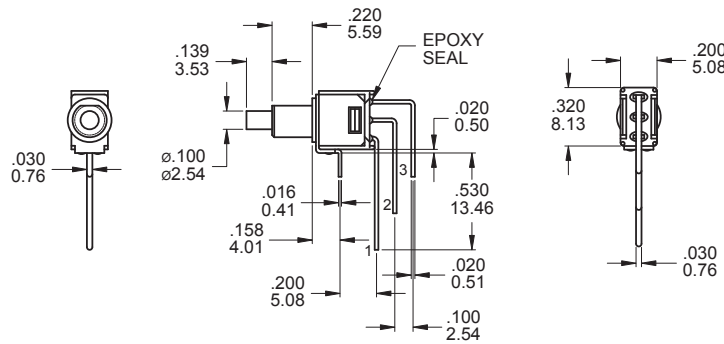

SPDT

Part No. Shown : 8MS8P1B06M7QE

VS2

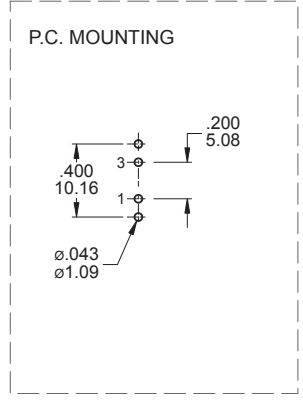
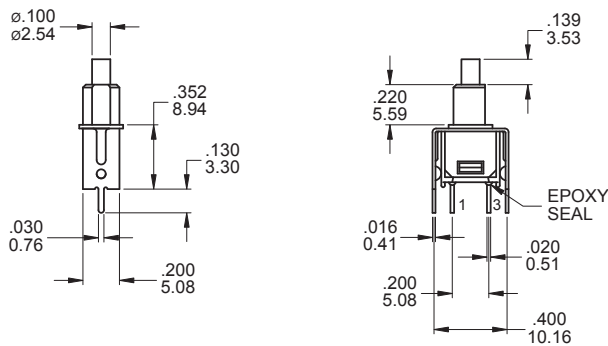

SPST

Part No. Shown : 8MS9P1B06VS2QE

8M Pushbutton Switches

VS2

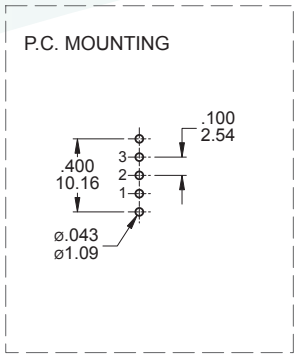
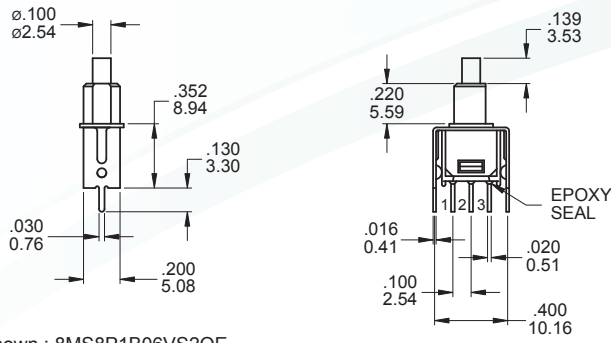

SPDT

Part No. Shown : 8MS8P1B06VS2QE

AP1

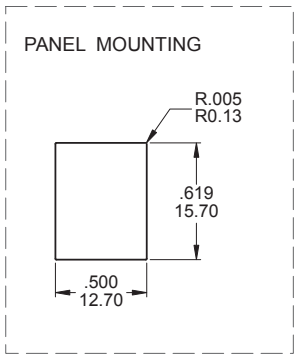
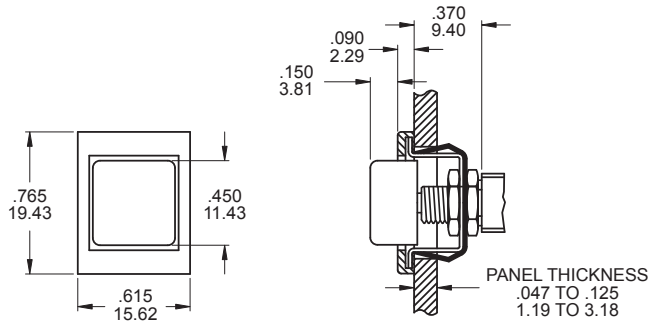

SPST

Part No. Shown : 8MS9AP122M1QE

SNAP-IN TERMINATION OPTIONS

M6N

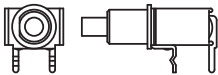

M7N

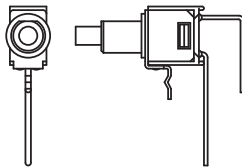

V2N

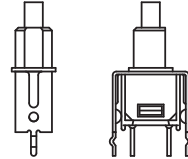

V3N

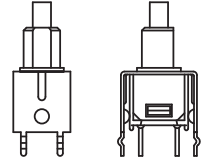

CAP OPTIONS

C1 For 8M Series ONLY

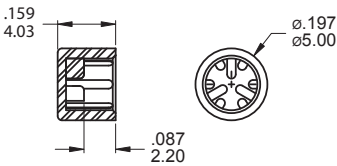

C2 For 8A,8B Series ONLY

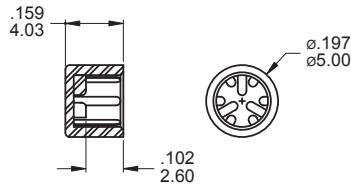

C3 For 8M Series B8,B9 Bushing ONLY

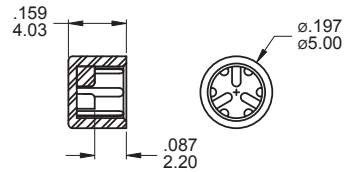

C4 For 8M Series ONLY

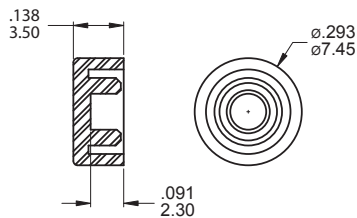

C5 For 8A,8B Series ONLY

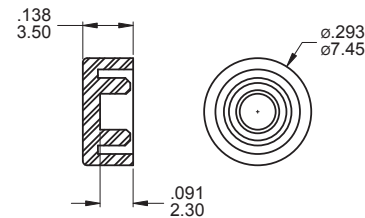

Cap Color : White, Black, Red, Green



SWITCH FUNCTION

SPECIFICATIONS

RATING: 1A 250VAC, 3A 120VAC or 28VDC
MECHANICAL LIFE: 6,000 cycles.
CONTACT RESISTANCE: R=20 mΩ max. ,Q=50 mΩ max.
INSULATION RESISTANCE: 1,000 MΩ min., 1000VDC
DIELECTRIC STRENGTH: 1,000 VAC for 1 Minute.
OPERATING TEMPERATURE: -30°C to 85°C.
FULL TRAVEL: 1.88±0.30mm
OPERATING TRAVEL: 1.34±0.25mm
OPERATING FORCE: 350±100g

MATERIALS

CASE: Diallyl phthalate(DAP) (UL94V-0).
PLUNGER: Nylon glass fiber.
BUSHING: Brass,nickel plated.
HOUSING: Stainless.
SWITCH SUPPORT: Brass,tin plated.
CONTACT/TERMINAL:Brass, with silver or gold plated. (See Page 129)

NO. POLES	UL/CSA MODEL NO.	MODEL NO.	SWITCH FUNCTION	
			POS.1	POS.2
SP	Q28	8MSL	ON	ON
CONNECTED TERMINALS / SCHEMATIC				
			POS.1	POS.2
2-1			NC 1 2 (COMM) 3 NO	2-3
			NC 1 3 NO	2 (COMM)

POLE OPTIONS

M1

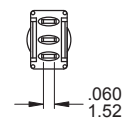
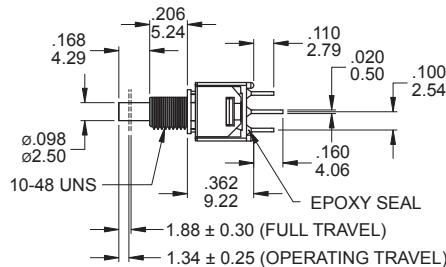
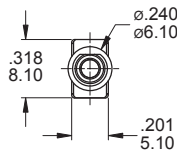

SPDT

Part No. Shown : 8MSLP1B05M1QE

M2

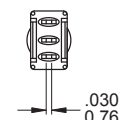
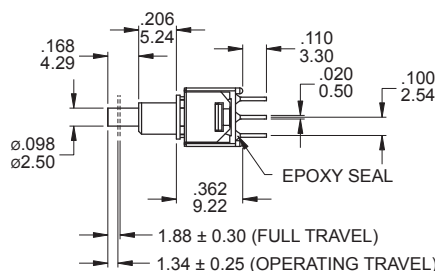
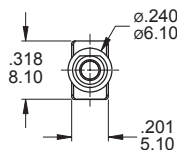

SPDT

Part No. Shown : 8MSLP1B06M2QE

BUSHING AND TERMINATION OPTIONS

B05 THD

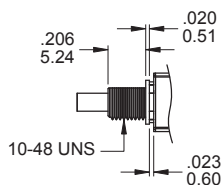
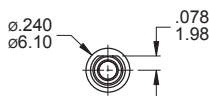

B06 NON-THD

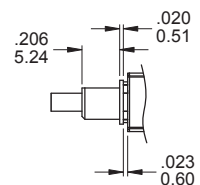
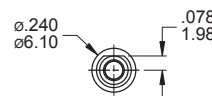

M1 Solder lug

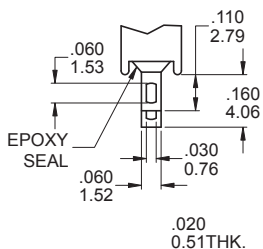

M2 PC Thru-hole

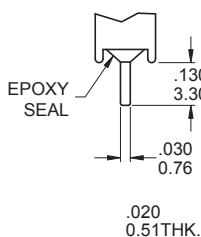

M5 Wire Wrap

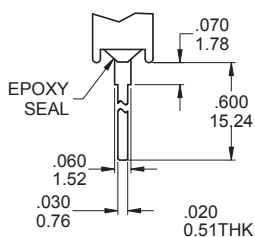

OTHER TERMINATION OPTIONS

- M6** RIGHT ANGLE P.C. MOUNT
- M7** RIGHT ANGLE P.C. MOUNT
- VS2** VERTICAL BRACKET P.C. MOUNT



M6

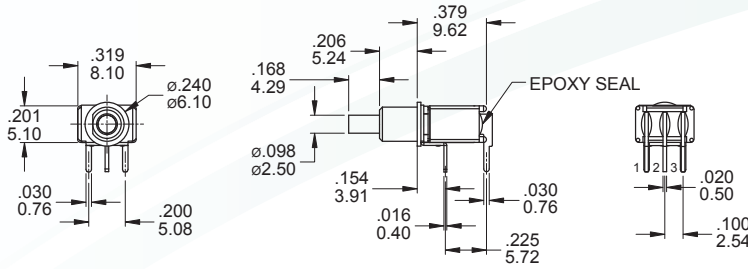

P.C. MOUNTING

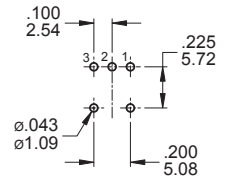

SPDT

Part No. Shown : 8MSLP1B06M6QE

M7

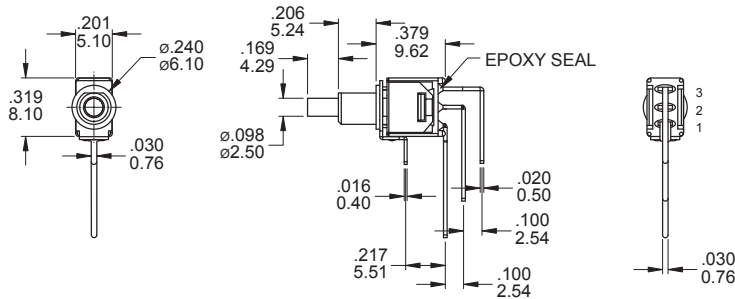
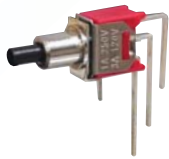

P.C. MOUNTING

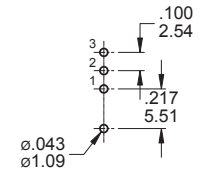

SPDT

Part No. Shown : 8MSLP1B06M7QE

VS2

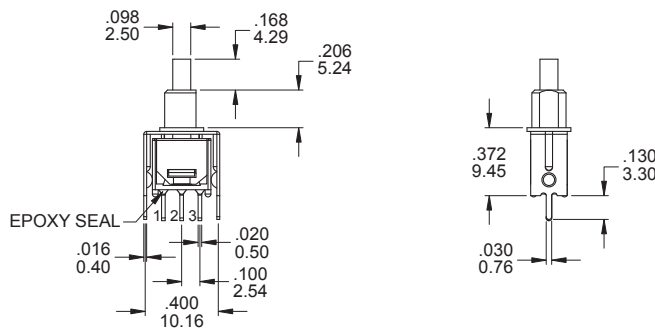

P.C. MOUNTING

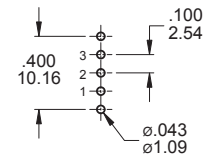

SPDT

Part No. Shown : 8MSLP1B06VS2QE

CONTACT MATERIAL OPTIONS

	CONTACT PLATING	TERMINAL PLATING	RATINGS
Q	Silver	Q = Silver	3 Amps with resistant load @ 120VAC or 28VDC 1 Amps with resistant load @ 250VAC
S		S = Silver,pure - tin	
C	Gold over Silver	C = Gold over silver	
K		K = Gold over silver,pure - tin	
R	Gold	R = Gold	0.4 Volt - Amps (VA) max. @ 20V max. (AC or DC)
G		G = Gold,pure - tin	

SOLDERING PROCESSES

MANUAL SOLDERING: Use soldering iron of 30 watts, controlled at 350°C approximately 5 seconds while applying solder.

WAVE SOLDERING: Recommended Soldering Temperature: 260 ± 5°C

Duration of Solder Immersion: Max 5 sec. (PCB is 1.6mm in thickness)